

Article number: 201134109

Description: E+G Guide bush DIN 172-B26-20-A
with collar

Measures

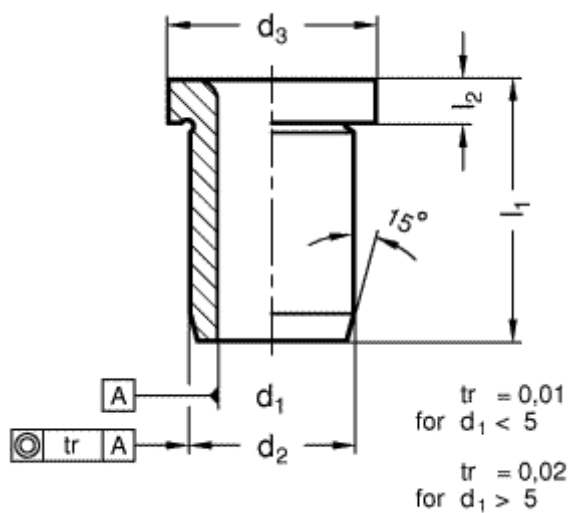

d1 = 28

d2 = 42

d3 = 46

l1 = 25

l2 = 5